



Low-Input-Voltage, 300mA LDO Regulators with RESET in SOT and TDFN

MAX1963/MAX1976

General Description

The MAX1963/MAX1976 low-dropout linear regulators operate from a +1.62V to +3.6V supply and deliver a guaranteed 300mA continuous load current with a low 100mV dropout. The high-accuracy ($\pm 0.5\%$) output voltage is preset to an internally trimmed voltage in the +0.75V to +3.0V range. An active-low, open-drain reset output remains asserted for at least 2.2ms (MAX1963) or 70ms (MAX1976) after the output voltage reaches regulation. These devices are offered in 6-pin thin SOT23 and 6-pin 3mm x 3mm thin DFN packages.

An internal PMOS pass transistor allows the low supply current to remain independent of load and dropout voltage, making these devices ideal for portable battery-powered equipment such as personal digital assistants (PDAs), cell phones, cordless phones, and notebook computers. Other features include logic-controlled shutdown, short-circuit protection, and thermal-overload protection.

Applications

Notebook Computers
Cellular and PCS Telephones
Personal Digital Assistants (PDAs)
Hand-Held Computers
Digital Cameras
PCMCIA Cards
CD and MP3 Players

Pin Configurations

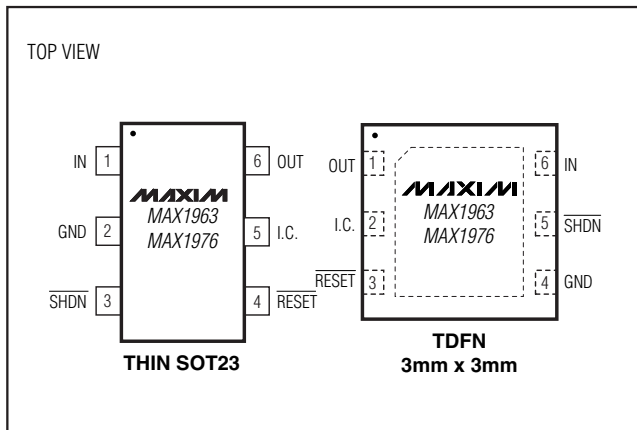

Selector Guide appears at end of data sheet.

Features

- ◆ Low 1.62V Minimum Input Voltage
- ◆ Guaranteed 300mA Output Current
- ◆ $\pm 2.5\%$ Accuracy Over Load/Line/Temp
- ◆ Low 100mV Dropout at 300mA Load
- ◆ 2.2ms (MAX1963) or 70ms (MAX1976) RESET Output Flag
- ◆ Supply Current Independent of Load and Dropout Voltage
- ◆ Logic-Controlled Shutdown
- ◆ Thermal-Overload and Short-Circuit Protection
- ◆ Preset Output Voltages (0.75V to 3.0V)
- ◆ Tiny 6-Pin Thin SOT23 Package (<1.1mm High)
- ◆ Thin 6-Pin TDFN Package (<0.8mm High)

Ordering Information

PART*	TEMP RANGE	PIN-PACKAGE
MAX1963EZT__-T	-40°C to +85°C	6 Thin SOT23-6
MAX1963ETT__-T	-40°C to +85°C	6 TDFN
MAX1976EZT__-T	-40°C to +85°C	6 Thin SOT23-6
MAX1976ETT__-T	-40°C to +85°C	6 TDFN

*Insert the desired three-digit suffix (see the Selector Guide) into the blanks to complete the part number. Contact the factory for other output voltages.

Typical Operating Circuit

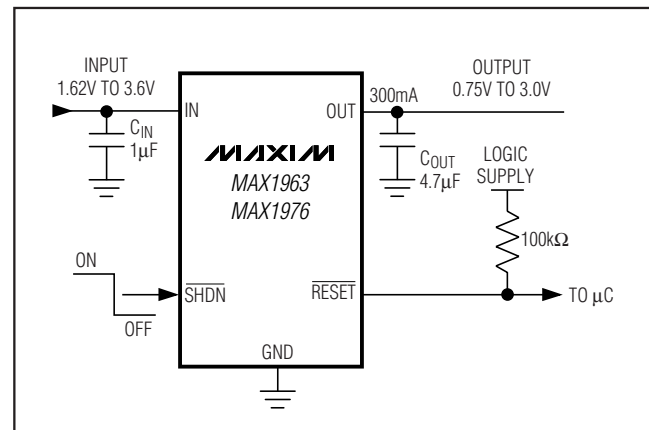

Low-Input-Voltage, 300mA LDO Regulators with RESET in SOT and TDFN

ABSOLUTE MAXIMUM RATINGS

IN, SHDN, RESET to GND-0.3V to +4.0V
 OUT to GND-0.3V to (VIN + 0.3V)
 Output Short-Circuit Duration.....Continuous
 Continuous Power Dissipation (TA = +70°C)
 6-Pin SOT23 (derate 9.1mW/°C above +70°C).....727mW
 6-Pin TDFN (derate 24.4mW/°C above +70°C)1951mW

Operating Temperature Range-40°C to +85°C
 Junction Temperature +150°C
 Storage Temperature Range-65°C to +150°C
 Lead Temperature (soldering, 10s)+300°C

Stresses beyond those listed under "Absolute Maximum Ratings" may cause permanent damage to the device. These are stress ratings only, and functional operation of the device at these or any other conditions beyond those indicated in the operational sections of the specifications is not implied. Exposure to absolute maximum rating conditions for extended periods may affect device reliability.

ELECTRICAL CHARACTERISTICS

(VIN = (VOUT + 0.5V) or 1.8V, whichever is greater; SHDN = IN, CIN = 1μF, COUT = 4.7μF, TA = -40°C to +85°C, unless otherwise noted. Typical values are at TA = +25°C.) (Note 1)

PARAMETER	SYMBOL	CONDITIONS	MIN	TYP	MAX	UNITS
Input Voltage	VIN		1.62		3.60	V
Input Undervoltage Lockout	VUVLO	VIN rising or falling (180mV typical hysteresis)	1.30		1.60	V
Output Voltage Accuracy		IOUT = 1mA to 300mA, VIN = (VOUT + 0.5V) to +3.6V	-2.5	±0.5	+2.5	%
Maximum Output Current	IOUT	Continuous	300			mA _{RMS}
Current Limit	ILIM	VOUT = 96% of nominal value	450	550	650	mA
Ground Current	IQ	No load		70	140	μA
		IOUT = 300mA		90		
		Dropout (Note 2)		70		
Dropout Voltage	VIN - VOUT	IOUT = 300mA, VOUT ≥ 1.8V (Note 2)		100	200	mV
Load Regulation	ΔVLDR	IOUT = 1mA to 300mA		0.02	0.3	%
Line Regulation	ΔVLNR	VIN = (VOUT + 0.5V) to +3.6V, IOUT = 1mA	-0.15	+0.01	+0.15	%/V
Output Noise		10Hz to 100kHz, IOUT = 10mA, VOUT = 1.5V		86		μV _{RMS}
PSRR		f < 1kHz, IOUT = 10mA		70		dB
SHUTDOWN						
Shutdown Supply Current	IOFF	SHDN = GND	TA = +25°C	0.001	1	μA
			TA = +85°C	0.01		
SHDN Input Logic Levels	VIH	VIN = 1.62V to 3.6V	1.4			V
	VIL	VIN = 1.62V to 3.6V			0.6	
SHDN Input Bias Current	ISHDN	VSHDN = 0 or 3.6V	TA = +25°C	1	100	nA
			TA = +85°C	5		
Turn-On Delay		From SHDN high to OUT high, VOUT = 1.8V		90		μs

Low-Input-Voltage, 300mA LDO Regulators with RESET in SOT and TDFN

MAX1963/MAX1976

ELECTRICAL CHARACTERISTICS (continued)

($V_{IN} = (V_{OUT} + 0.5V)$ or 1.8V, whichever is greater; $\overline{SHDN} = IN$, $C_{IN} = 1\mu F$, $C_{OUT} = 4.7\mu F$, $T_A = -40^\circ C$ to $+85^\circ C$, unless otherwise noted. Typical values are at $T_A = +25^\circ C$.) (Note 1)

PARAMETER	SYMBOL	CONDITIONS	MIN	TYP	MAX	UNITS	
RESET OUTPUT							
Reset Threshold Accuracy		V_{OUT} falling, (1.7% typical hysteresis)	80	82.5	85	% V_{OUT}	
\overline{RESET} Output Low Voltage	V_{OL}	$I_{\overline{RESET}} = 100\mu A$		1	100	mV	
		$V_{IN} = +1.0V$, $I_{\overline{RESET}} = 100\mu A$		30	400		
\overline{RESET} Output High Leakage	I_{OH}	$V_{\overline{RESET}} = 3.6V$, \overline{RESET} not asserted	$T_A = +25^\circ C$	0.001	1	μA	
			$T_A = +85^\circ C$	0.01			
Reset Delay	t_{RP}	From V_{OUT} high to \overline{RESET} rising	MAX1963	2.2	3.2	5.5	ms
			MAX1976	70	100	160	
THERMAL PROTECTION							
Thermal-Shutdown Temperature	T_{SHDN}			+165		$^\circ C$	
Thermal-Shutdown Hysteresis	ΔT_{SHDN}			15		$^\circ C$	

Note 1: Limits are 100% production tested at $T_A = +25^\circ C$. Limits over the operating temperature range are guaranteed by design.

Note 2: The dropout voltage is defined as $V_{IN} - V_{OUT}$, when V_{OUT} is 4% lower than the value of V_{OUT} when $V_{IN} = V_{OUT} + 0.5V$.

Typical Operating Characteristics

($V_{IN} = (V_{OUT} + 0.5V)$ or 1.8V, whichever is greater; $\overline{SHDN} = IN$, $C_{IN} = 1\mu F$, $C_{OUT} = 4.7\mu F$, $T_A = +25^\circ C$, unless otherwise noted.)

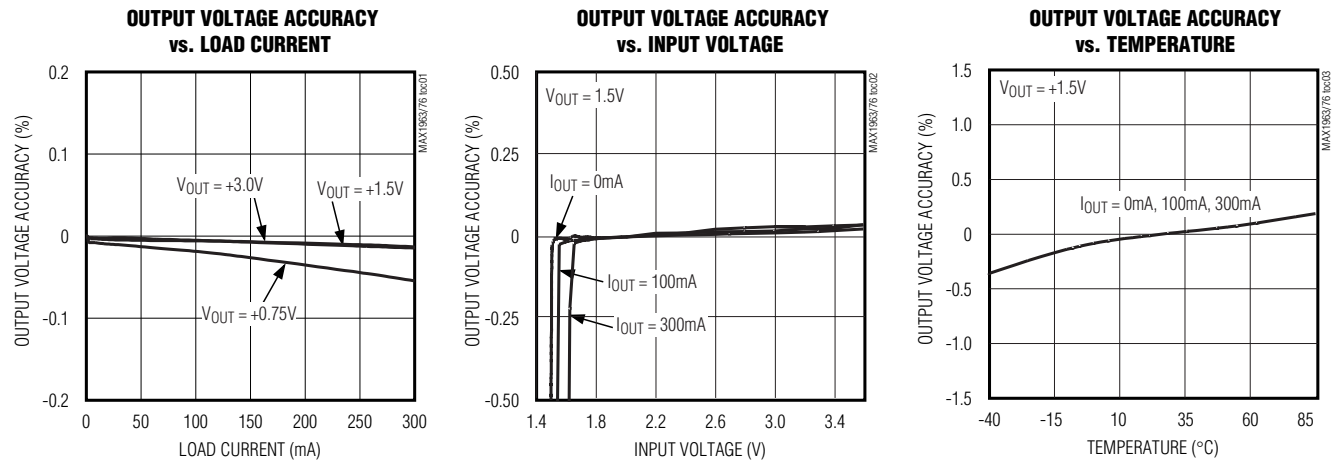

Low-Input-Voltage, 300mA LDO Regulators with RESET in SOT and TDFN

Typical Operating Characteristics (continued)

($V_{IN} = (V_{OUT} + 0.5V)$ or $1.8V$, whichever is greater; $\overline{SHDN} = IN$, $C_{IN} = 1\mu F$, $C_{OUT} = 4.7\mu F$, $T_A = +25^\circ C$, unless otherwise noted.)

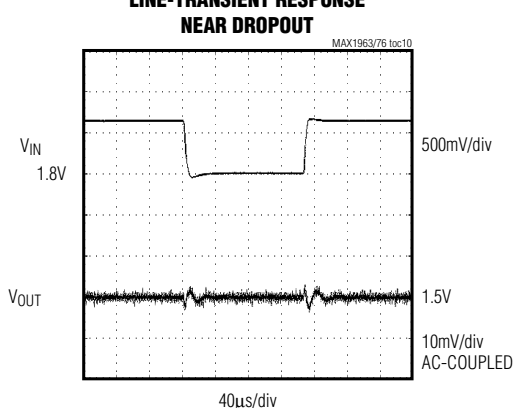
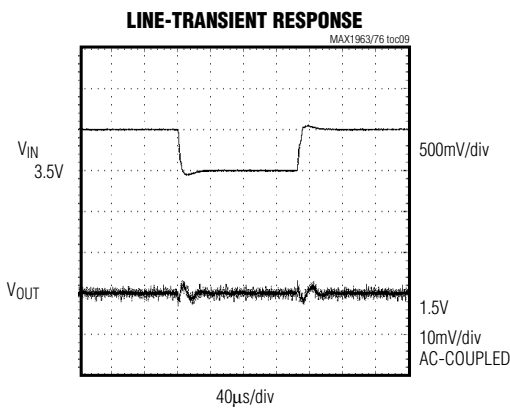
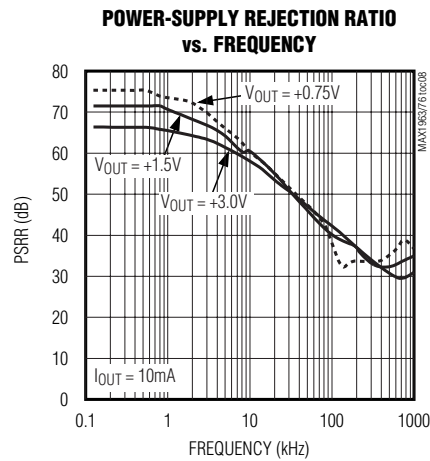
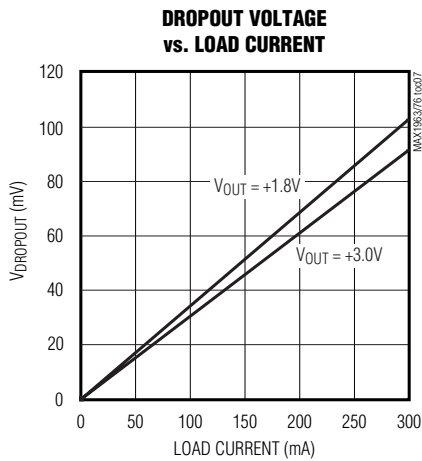
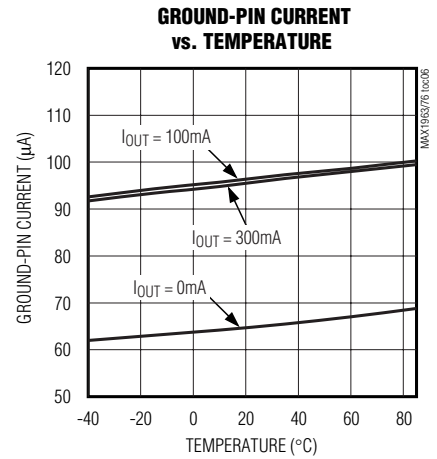
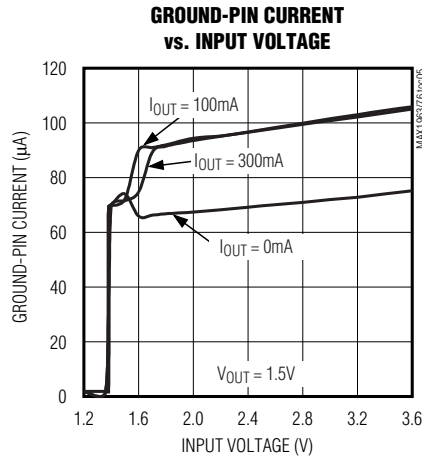
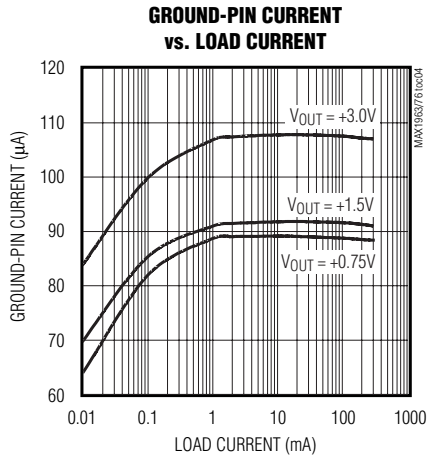

Low-Input-Voltage, 300mA LDO Regulators with RESET in SOT and TDFN

Typical Operating Characteristics (continued)

($V_{IN} = (V_{OUT} + 0.5V)$ or 1.8V, whichever is greater; $\overline{SHDN} = IN$, $C_{IN} = 1\mu F$, $C_{OUT} = 4.7\mu F$, $T_A = +25^\circ C$, unless otherwise noted.)

MAX1963/MAX1976

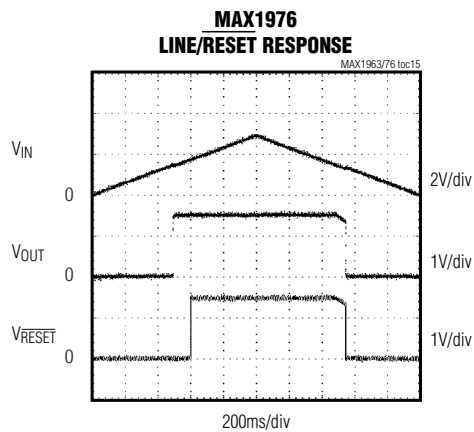
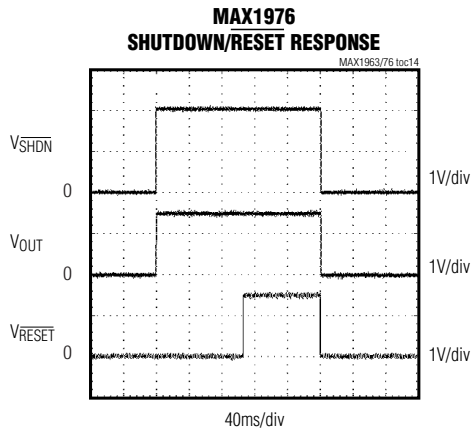
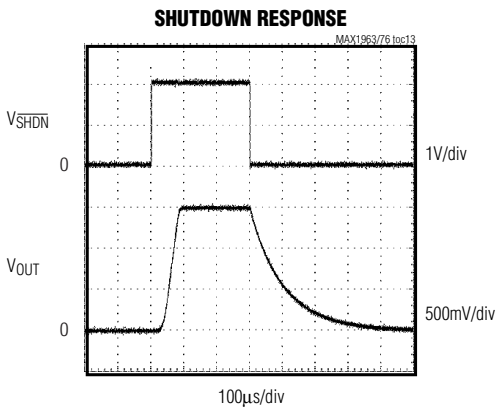
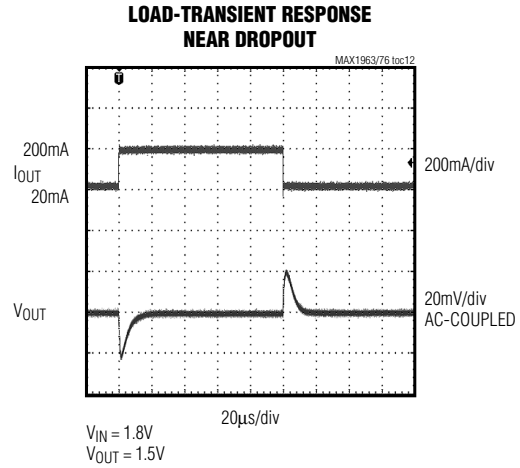
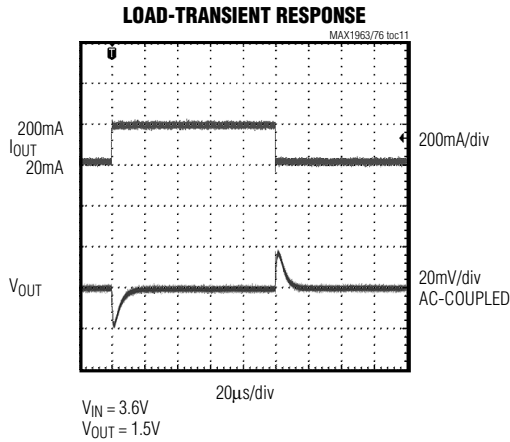

Low-Input-Voltage, 300mA LDO Regulators with RESET in SOT and TDFN

Pin Description

PIN		NAME	FUNCTION
SOT23	TDFN		
1	6	IN	Regulator Input. Supply voltage can range from +1.62V to +3.6V. Bypass IN with at least a 1 μ F ceramic capacitor to GND (see the <i>Capacitor Selection and Regulator Stability</i> section).
2	—	GND	Ground. GND also functions as a heatsink. Solder to a large pad or circuit-board ground plane to maximize SOT23 power dissipation.
—	4	GND	Ground
3	5	$\overline{\text{SHDN}}$	Active-Low Shutdown Input. A logic low reduces supply current to below 1 μ A. Connect to IN or logic high for normal operation.
4	3	$\overline{\text{RESET}}$	Open-Drain, Active-Low Reset Output. $\overline{\text{RESET}}$ rises 3.2ms (MAX1963) or 100ms (MAX1976) after the output has achieved regulation. $\overline{\text{RESET}}$ falls immediately if V_{OUT} drops below 82.5% of its nominal voltage, or if the MAX1963/MAX1976 are shut down.
5	2	I.C.	Internally Connected. Leave floating or connect to GND.
6	1	OUT	Regulator Output. Sources up to 300mA. Bypass with a 4.7 μ F low-ESR ceramic capacitor to GND.
—	Exposed Pad	EP	Ground. EP also functions as a heatsink. Solder EP to a large pad or circuit-board ground plane to maximize TDFN power dissipation.

Detailed Description

The MAX1963/MAX1976 are low-dropout, high-accuracy, low-quiescent-current linear regulators designed primarily for battery-powered applications. These devices supply loads up to 300mA and are available with preset output voltages from +0.75V to +3.0V. As illustrated in Figure 1, the MAX1963/MAX1976 consist of a reference, an error amplifier, a P-channel pass transistor, an internal feedback voltage-divider, and a power-good comparator.

The reference is connected to the error amplifier, which compares this reference with the feedback voltage and amplifies the difference. If the feedback voltage is lower than the reference voltage, the pass-transistor gate is pulled lower, which allows more current to pass to the output and increases the output voltage. If the feedback voltage is too high, the pass-transistor gate is pulled up, allowing less current to pass to the output.

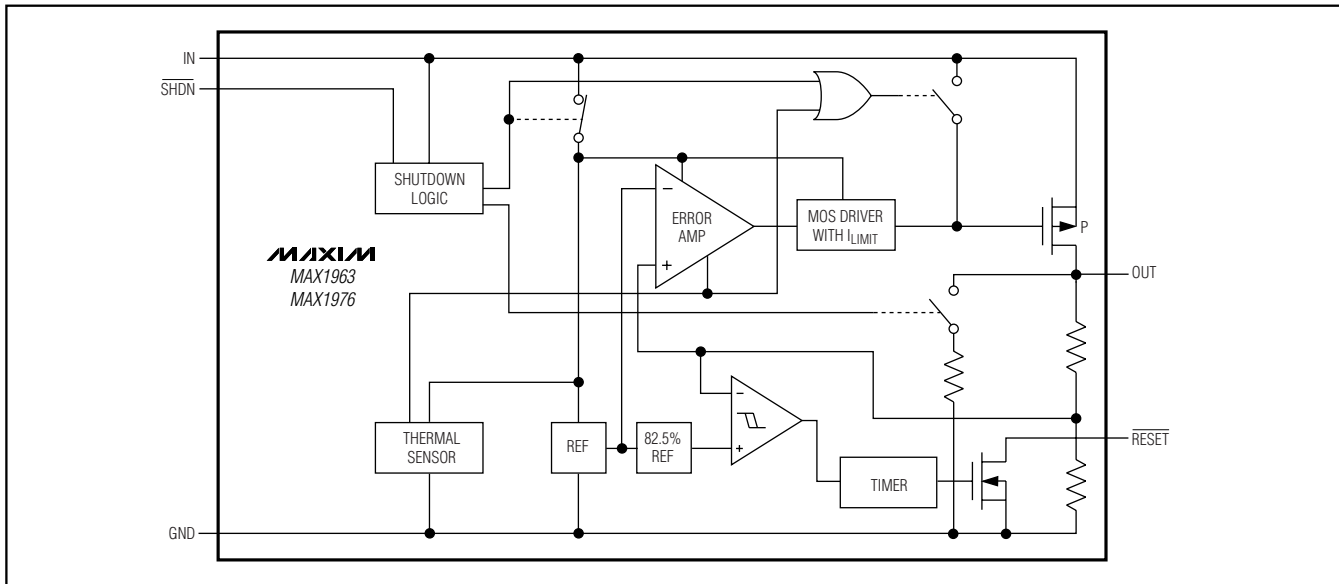

Figure 1. Functional Diagram

Low-Input-Voltage, 300mA LDO Regulators with RESET in SOT and TDFN

MAX1963/MAX1976

Internal P-Channel Pass Transistor

The MAX1963/MAX1976 feature a 0.33Ω ($R_{DS(ON)}$) P-channel MOSFET pass transistor. Unlike similar designs using PNP pass transistors, P-channel MOSFETs require no base drive, which reduces quiescent current. PNP-based regulators also waste considerable current in dropout when the pass transistor saturates and use high base-drive currents under large loads. The MAX1963/MAX1976 do not suffer from these problems and consume only $90\mu\text{A}$ (typ) of quiescent current under heavy loads, as well as in dropout.

Shutdown

Pull $\overline{\text{SHDN}}$ low to enter shutdown. During shutdown, the output is disconnected from the input, an internal $1.5\text{k}\Omega$ resistor pulls OUT to GND, $\overline{\text{RESET}}$ is actively pulled low, and the supply current drops below $1\mu\text{A}$.

RESET Output

The MAX1963/MAX1976 microprocessor (μP) supervisory circuitry asserts a guaranteed logic-low reset during power-up, power-down, and brownout conditions down to $+1\text{V}$. $\overline{\text{RESET}}$ asserts when V_{OUT} is below the reset threshold and remains asserted for at least t_{RP} after V_{OUT} rises above the reset threshold of regulation.

Current Limit

The MAX1963/MAX1976 monitor and control the pass transistor's gate voltage, limiting the output current to 450mA (min). If the output exceeds I_{LIM} , the MAX1963/MAX1976 output voltage drops.

Thermal-Overload Protection

Thermal-overload protection limits total power dissipation in the MAX1963/MAX1976. When the junction temperature exceeds $T_{\text{J}} = +165^{\circ}\text{C}$, a thermal sensor turns off the pass transistor, allowing the IC to cool. The thermal sensor turns the pass transistor on again after the junction temperature cools by 15°C , resulting in a pulsed output during continuous thermal-overload conditions. Thermal-overload protection safeguards the MAX1963/MAX1976 in the event of fault conditions. For continuous operation, do not exceed the absolute maximum junction-temperature rating of $T_{\text{J}} = +150^{\circ}\text{C}$.

Operating Region and Power Dissipation

The MAX1963/MAX1976 maximum power dissipation depends on the thermal resistance of the IC package and circuit board, the temperature difference between the die junction and ambient air, and the rate of airflow. The power dissipated in the device is $P = I_{\text{OUT}} \times (V_{\text{IN}} - V_{\text{OUT}})$. The maximum allowed power dissipation is:

$$P_{\text{MAX}} = (T_{\text{J}(\text{MAX})} - T_{\text{A}}) / (\theta_{\text{JC}} + \theta_{\text{CA}})$$

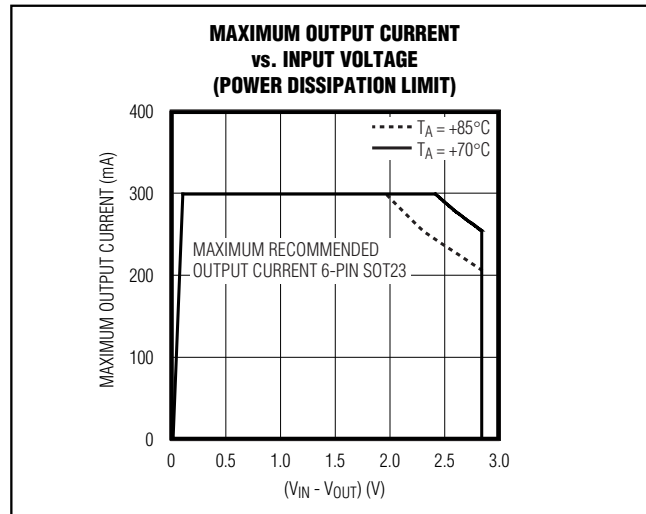

Figure 2. Power Operating Regions for the 6-Pin SOT23: Maximum Output Current vs. Input Voltage

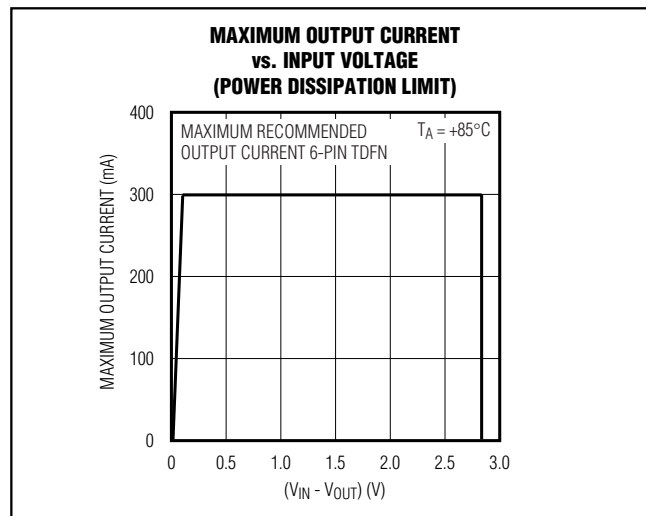

Figure 3. Power Operating Regions for the 6-Pin TDFN: Maximum Output Current vs. Input Voltage

where $(T_{\text{J}(\text{MAX})} - T_{\text{A}})$ is the temperature difference between the MAX1963/MAX1976 die junction and the surrounding air, θ_{JC} is the thermal resistance of the junction to the case, and θ_{CA} is the thermal resistance from the case through the PC board, copper traces, and other materials to the surrounding air. For best heatsinking, expand the copper connected to the exposed paddle or GND.

Low-Input-Voltage, 300mA LDO Regulators with RESET in SOT and TDFN

The MAX1963/MAX1976 deliver up to 300mA and operate with an input voltage up to +3.6V. However, when using the 6-pin SOT23 version, high output currents can only be sustained when the input-output differential voltage is less than 2V, as shown in Figure 2.

The maximum allowed power dissipation for the 6-pin TDFN is 1.951W at $T_A = +70^\circ\text{C}$. Figure 3 shows that the maximum input-output differential voltage is not limited by the TDFN package power rating.

Applications Information

Capacitor Selection and Regulator Stability

Capacitors are required at the MAX1963/MAX1976 input and output for stable operation over the full temperature range and with load currents up to 300mA. Connect a 1 μF ceramic capacitor between IN and GND and a 4.7 μF low-ESR ceramic capacitor between OUT and GND. The input capacitor (C_{IN}) lowers the source impedance of the input supply. Use larger output capacitors to reduce noise and improve load-transient response, stability, and power-supply rejection.

The output capacitor's equivalent series resistance (ESR) affects stability and output noise. Use output capacitors with an ESR of 30m Ω or less to ensure stability and optimize transient response. Surface-mount ceramic capacitors have very low ESR and are commonly available in values up to 10 μF . Connect C_{IN} and C_{OUT} as close to the MAX1963/MAX1976 as possible to minimize the impact of PC board trace inductance.

Noise, PSRR, and Transient Response

The MAX1963/MAX1976 are designed to operate with low dropout voltages and low quiescent currents in battery-powered systems while still maintaining good noise, transient response, and AC rejection. See the *Typical Operating Characteristics* for a plot of Power-Supply Rejection Ratio (PSRR) versus Frequency. When operating from noisy sources, improved supply-noise rejection and transient response can be achieved by increasing the values of the input and output bypass capacitors and through passive filtering techniques.

The MAX1963/MAX1976 load-transient response (see the *Typical Operating Characteristics*) shows two components of the output response: a near-zero DC shift from the output impedance due to the load-current change, and the transient response. A typical transient

response for a step change in the load current from 20mA to 200mA is 20mV. Increasing the output capacitor's value and decreasing the ESR attenuates the overshoot.

Input-Output (Dropout) Voltage

A regulator's minimum input-output voltage difference (dropout voltage) determines the lowest usable supply voltage. In battery-powered systems, this determines the useful end-of-life battery voltage. Because the MAX1963/MAX1976 use a P-channel MOSFET pass transistor, the dropout voltage is a function of drain-to-source on-resistance ($R_{DS(ON)} = 0.33\Omega$) multiplied by the load current (see the *Typical Operating Characteristics*).

$$V_{DROPOUT} = V_{IN} - V_{OUT} = 0.33\Omega \times I_{OUT}$$

The MAX1963/MAX1976 ground current reduces to 70 μA in dropout.

Selector Guide

V _{OUT} (V)	SUFFIX	MAX1963 TOP MARK		MAX1976 TOP MARK	
		SOT	TDFN	SOT	TDFN
0.75	075	AABA	AFQ	AAAQ	AGA
0.85	085	—	—	AABP	AHD
0.90	090	AABB	AFR	AABK	AGB
1.00	100	AABC	AFS	AABL	AGC
1.10	110	AABD	AFT	AABM	AGD
1.20	120	AABE	AFU	AAAK	AGE
1.30	130	AABF	AFV	AABN	AGF
1.50	150	AABG	AFW	AAAL	AGG
1.60	160	—	—	AABO	AHC
1.80	180	AABH	AFX	AAAM	AGH
2.50	250	AABI	AFY	AAAN	AGI
2.85	285	—	—	AAAO	AGJ
3.00	300	AABJ	AFZ	AAAP	AGK

(Note: Standard voltage options, shown in **bold**, are available. Contact the factory for other output voltages between 1.5V and 4.5V. Minimum order quantity is 15,000 units.)

Chip Information

TRANSISTOR COUNT: 2556

PROCESS: BiCMOS

Low-Input-Voltage, 300mA LDO Regulators with RESET in SOT and TDFN

Package Information

(The package drawing(s) in this data sheet may not reflect the most current specifications. For the latest package outline information, go to www.maxim-ic.com/packages.)

MAX1963/MAX1976

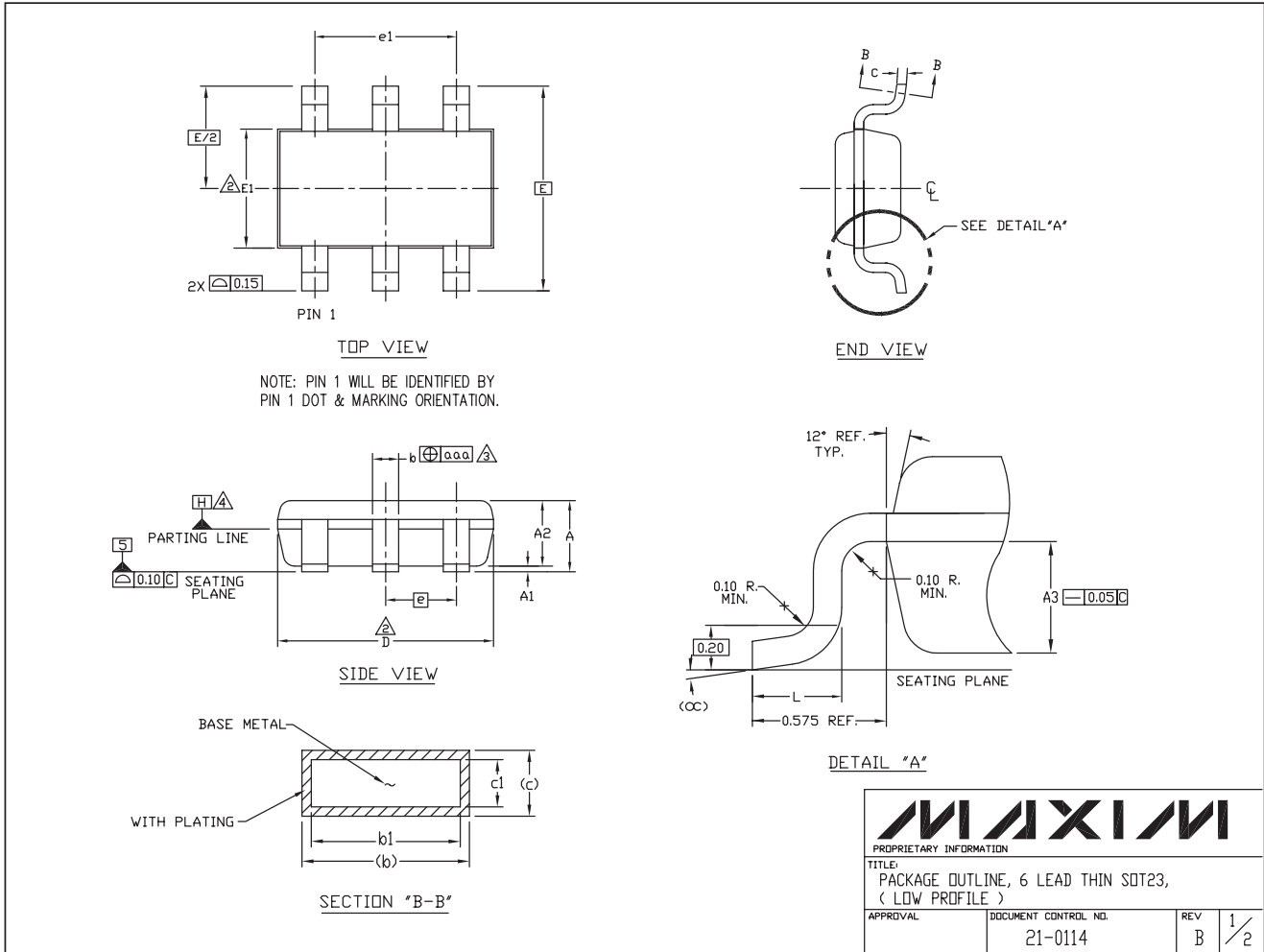

Low-Input-Voltage, 300mA LDO Regulators with RESET in SOT and TDFN

Package Information (continued)

(The package drawing(s) in this data sheet may not reflect the most current specifications. For the latest package outline information, go to www.maxim-ic.com/packages.)

NOTES:

1. ALL DIMENSIONS ARE IN MILLIMETERS.

2. "D" AND "E1" ARE REFERENCE DATUM AND DO NOT INCLUDE MOLD FLASH OR PROTRUSIONS, AND ARE MEASURED AT THE BOTTOM PARTING LINE. MOLD FLASH OR PROTRUSION SHALL NOT EXCEED 0.15mm ON "D" AND 0.25mm ON "E" PER SIDE.

3. THE LEAD WIDTH DIMENSION DOES NOT INCLUDE DAMBAR PROTRUSION. ALLOWABLE DAMBAR PROTRUSION SHALL BE 0.07mm TOTAL IN EXCESS OF THE LEAD WIDTH DIMENSION AT MAXIMUM MATERIAL CONDITION.

4. DATUM PLANE "H" LOCATED AT MOLD PARTING LINE AND COINCIDENT WITH LEAD, WHERE LEAD EXITS PLASTIC BODY AT THE BOTTOM OF PARTING LINE.

5. THE LEAD TIPS MUST LINE WITHIN A SPECIFIED TOLERANCE ZONE. THIS TOLERANCE ZONE IS DEFINED BY TWO PARALLEL LINES. ONE PLANE IS THE SEATING PLANE, DATUM [-C-]; AND THE OTHER PLANE IS AT THE SPECIFIED DISTANCE FROM [-C-] IN THE DIRECTION INDICATED. FORMED LEADS SHALL BE PLANAR WITH RESPECT TO ONE ANOTHER WITH 0.10mm AT SEATING PLANE.

6. THIS PART IS COMPLIANT WITH JEDEC SPECIFICATION MO-193 EXCEPT FOR THE "e" DIMENSION WHICH IS 0.95mm INSTEAD OF 1.00mm. THIS PART IS IN FULL COMPLIANCE TO EIAJ SPECIFICATION SC-74.

SYMBOLS			
	MIN	NOM	MAX
A	-	-	1.10
A1	0.05	0.075	0.10
A2	0.85	0.88	0.90
A3	0.50 BSC		
b	0.30	-	0.45
b1	0.25	0.35	0.40
c	0.15	-	0.20
c1	0.12	0.127	0.15
D	2.80	2.90	3.00
E	2.75 BSC		
E1	1.55	1.60	1.65
L	0.30	0.40	0.50
e1	1.90 BSC		
e	0.95 BSC		
CC	0°	4°	8°
aaa	0.20		

		
<small>PROPRIETARY INFORMATION</small>		
<small>TITLE:</small> PACKAGE OUTLINE, 6 LEAD THIN SOT23, (LOW PROFILE)		
<small>APPROVAL</small>	<small>DOCUMENT CONTROL NO.</small> 21-0114	<small>REV</small> B 2/2

Low-Input-Voltage, 300mA LDO Regulators with RESET in SOT and TDFN

Package Information (continued)

(The package drawing(s) in this data sheet may not reflect the most current specifications. For the latest package outline information, go to www.maxim-ic.com/packages.)

MAX1963/MAX1976

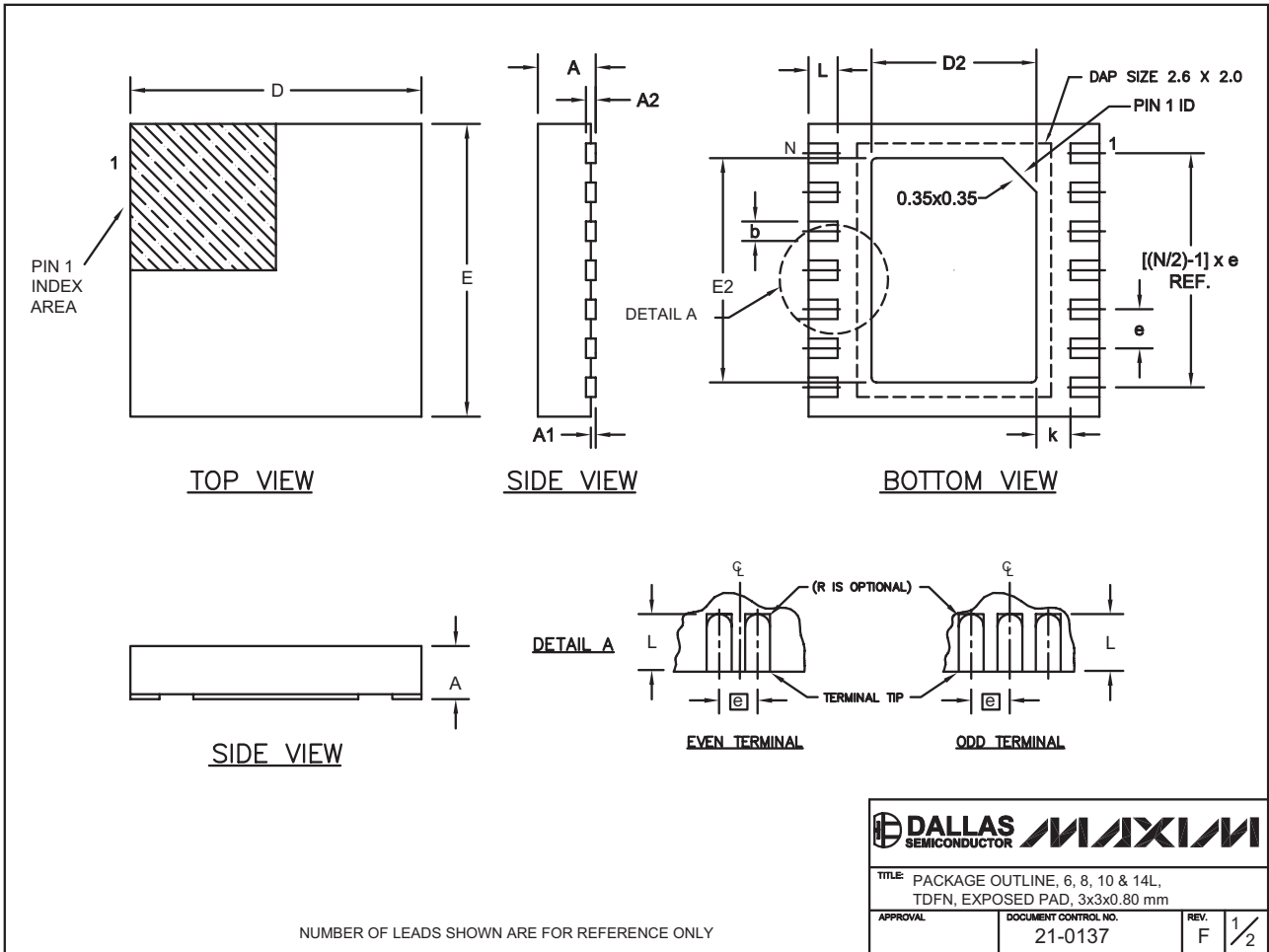

NUMBER OF LEADS SHOWN ARE FOR REFERENCE ONLY

TITLE: PACKAGE OUTLINE, 6, 8, 10 & 14L, TDFN, EXPOSED PAD, 3x3x0.80 mm	
APPROVAL	DOCUMENT CONTROL NO. 21-0137
REV. F	1/2

Low-Input-Voltage, 300mA LDO Regulators with RESET in SOT and TDFN

Package Information (continued)

(The package drawing(s) in this data sheet may not reflect the most current specifications. For the latest package outline information, go to www.maxim-ic.com/packages.)

COMMON DIMENSIONS		
SYMBOL	MIN.	MAX.
A	0.70	0.80
D	2.90	3.10
E	2.90	3.10
A1	0.00	0.05
L	0.20	0.40
k	0.25 MIN.	
A2	0.20 REF.	

PACKAGE VARIATIONS							
PKG. CODE	N	D2	E2	e	JEDEC SPEC	b	[(N/2)-1] x e
T633-1	6	1.50±0.10	2.30±0.10	0.95 BSC	MO229 / WEEA	0.40±0.05	1.90 REF
T833-1	8	1.50±0.10	2.30±0.10	0.65 BSC	MO229 / WEEC	0.30±0.05	1.95 REF
T1033-1	10	1.50±0.10	2.30±0.10	0.50 BSC	MO229 / WEED-3	0.25±0.05	2.00 REF
T1433-1	14	1.70±0.10	2.30±0.10	0.40 BSC	----	0.20±0.03	2.40 REF
T1433-2	14	1.70±0.10	2.30±0.10	0.40 BSC	----	0.20±0.03	2.40 REF

NOTES:

1. ALL DIMENSIONS ARE IN mm. ANGLES IN DEGREES.
2. COPLANARITY SHALL NOT EXCEED 0.08 mm.
3. WARPAGE SHALL NOT EXCEED 0.10 mm.
4. PACKAGE LENGTH/PACKAGE WIDTH ARE CONSIDERED AS SPECIAL CHARACTERISTIC(S).
5. DRAWING CONFORMS TO JEDEC MO229, EXCEPT DIMENSIONS "D2" AND "E2", AND T1433-1 & T1433-2.
6. "N" IS THE TOTAL NUMBER OF LEADS.

		
TITLE: PACKAGE OUTLINE, 6, 8, 10 & 14L, TDFN, EXPOSED PAD, 3x3x0.80 mm		
APPROVAL	DOCUMENT CONTROL NO.	REV.
	21-0137	F 2/2

Maxim cannot assume responsibility for use of any circuitry other than circuitry entirely embodied in a Maxim product. No circuit patent licenses are implied. Maxim reserves the right to change the circuitry and specifications without notice at any time.

12 _____ **Maxim Integrated Products, 120 San Gabriel Drive, Sunnyvale, CA 94086 408-737-7600**